



**ILLINOIS STATE UNIVERSITY**  
**EXHIBIT FS-8.1: ELECTRONIC ACCESS GUIDELINES**  
Effective February 1, 2023

**I. SUMMARY**

- A. This electronic access guideline describes the furnishing, installation, and commissioning of a wired and/or wireless door access system's components and infrastructure. This guideline assists in determining the requirements indicated in *ISU Facilities Standards*, Section 08 74 13 – Electronic Access Systems.
- B. ISU Electronic Access Guidelines are to be used in all construction on ISU owned or leased properties (including remodels) for use by ISU.
- C. Configuration of system design and installation shall be coordinated through the Hirsch Certified Illinois State University Systems Manager (hereafter referred as ISU FM Systems Manager), appointed firms, or vendors.
- D. Provide wired and/or wireless door access control system components and infrastructure as specified herein and as indicated on the attached reference drawings.
- E. Refer to the Hirsch DIGI\*TRAC™ System Design and Installation Guide for design installation and submit questions to ISU FM Systems Manager.
- F. Clarification: The ISU Electronic Access Guidelines have been established to indicate minimum requirements only. These guidelines should not be used as a complete specification.

**II. REFERENCE DRAWINGS**

- A. See attached, electronic access, reference drawings located at the end of this electronic access guidelines.
  - 1. A1.1 Exterior Single Door – Aluminum Door & Frame
  - 2. A1.2 Exterior Single Door: Aluminum Door & Frame with ADA Hardware
  - 3. A1.3 Exterior Single Door – Steel Door & Frame
  - 4. A1.4 Exterior Single Door – Steel Door & Frame with ADA Hardware
  - 5. A2.1 Interior Single Door – Wood/Steel Door with H.M. Frame
  - 6. A2.2 Interior Single Door – Wood/Steel Door with H.M. Frame & Reader
  - 7. A3.1 Exterior Double Door – Aluminum Door & Frame
  - 8. A3.2 Exterior Double Door – Aluminum Door & Frame with ADA Hardware
  - 9. A4.1 Interior Double Door – Wood/Steel Door with H.M. Frame & Reader
  - 10. A4.2 Interior Double Door – Wood/Steel Door with H.M. Frame & Mullion



### **III. QUALITY ASSURANCE**

- A. Installer: The installing contractor must be Hirsch-certified. The division of responsibility will be assigned, by the ISU FM Systems Manager, depending on the size of the project, Contractor/ISU Trades involvement, and integration with existing door access system.
- B. The ISU FM Systems Manager shall certify all installations.
- C. All installations shall comply with the *National Electric Code, Illinois State University Design Guidelines*, and *Illinois State University Facilities Standards*.
- D. All components shall be UL listed.

### **IV. RECORD DRAWINGS**

- A. In addition to the requirements for record documents as specified elsewhere in these guidelines, as-built drawings shall document the entire installed wiring system. This documentation shall include detailed wiring diagram(s) (in AutoCAD and/or PDF format) and be submitted on both electronic and hard copy formats as part of project close-out.

### **V. SUBMITTALS**

- A. Submittals shall include the following:
  - 1. Drawings and load calculations for review and approval.
  - 2. Shop drawings.
  - 3. Mechanical/electrical notes and construction details for each device.
  - 4. Interconnection diagrams showing a detail of each device and interconnect wiring between devices.
  - 5. Catalog literature with performance specifications, which indicate compliance to the specifications herein.
  - 6. Complete instruction manuals, service manuals, parts lists, cut sheets, and current list of local service centers acceptable to the manufacturer.
  - 7. Systems provider/installer shall provide all additional information or demonstrations required by ISU FM Systems Manager to demonstrate conformance with specifications herein. Demonstrations shall be at a time and location coordinated with by ISU FM Systems Manager.
  - 8. Complete and submit attached, "Panel Wiring Form".



## **VI. EQUIPMENT**

### **A. Electronic Access Hardware**

1. All equipment shall be Hirsch/Identiv or Hirsch/Identiv compatible except for the following which must be Hirsch/Identiv:
  - a) Controllers
  - b) Modules / Add-on Products for Controllers
  - c) Line Modules
  - d) Match Reader Interfaces
2. All Hirsch/Identiv equipment is procured via State Contracts: 9100001186 and 9100000924.
3. Hirsch control panel shall be a MX-8 (MX-2 or MX-4 is acceptable under certain circumstances with prior, written approval of ISU FM Systems Manager) or MX1-ME (approved wireless systems only). Final panel configuration may include the following modules based on building needs for the project as determined by the ISU FM Systems Manager.
  - a) Relay Expansion Board (REB8)
  - b) Alarm Expansion Board (AEB8)
  - c) Scramble Net Interface Board (SNIB2/SNIB3)
  - d) Memory Expansion Board (MEB64)
  - e) Any other auxiliary expansion parts will be reviewed on a project-by-project basis.
4. Power Supply
  - a) At least 1 (one) power supply as described below shall be provided with each Hirsch controller as described in VI (A-3). Additional power supplies shall be furnished as required by ISU FM Systems Manager.
  - b) Power supply shall furnish regulated 24 VDC at not less than 4 amps and shall be UL class 2 listed.
  - c) Power supply shall provide 8 separate outputs to divide the load. Outputs shall consist of a PTC circuit breaker or “wet” relay, and 1 LED to indicate status (voltage/no voltage). Outputs shall be controlled by either:
    - (1) Physical switch
    - (2) Remote contact closure
  - d) Power supply shall be designed to charge optional sealed lead acid batteries in addition to operating the DC load.
  - e) Power supply shall be manufactured by Von Duprin, Securitron, Altronix, or Honeywell.
  - f) Power supply shall be provided with two 7.2 Ah 12V sealed lead acid batteries.



## FACILITIES PLANNING, DESIGN, AND CONSTRUCTION

*Illinois State University*

- g) Power supply enclosure shall be large enough to accommodate two 7.2 Ah 12V sealed lead acid batteries.
5. Card Readers
- a) Card readers exposed to the elements shall be weatherproof and mounting location shall be approved by ISU FM Systems Manager.
  - b) All card readers, whether wall mounted or integral to door hardware, must be capable of reading the secure section of HID SEOS credentials. Reading of CSN or other information to provide access is NOT acceptable.
  - c) All card readers, whether wall mounted or integral to door hardware, must be capable of reading the secure section of HID SEOS Mobile Access Credentials through BLE (Bluetooth Low Energy) and NFC (near field communications). Reading of CSN or other information to provide access is NOT acceptable.
  - d) All readers must be approved by ISU FM Systems Manager before ordering.
  - e) At least 1 (one) door in a bank of doors shall be operated through a card reader mounted on the exterior of the building or integral to the door hardware.
6. All equipment must be fail secure (locked when power is out).

### **B. Electronic Door Hardware**

- 1. See *ISU Facilities Standards*, Section 08 71 00 – Door Hardware for acceptable door hardware manufacturers and additional information.
- 2. ADA doors must utilize wired exit device or wired strike. Wireless locks are NOT acceptable with ADA doors.
  - a) Where an ADA compliant operator is required at an entrance, the door hardware and wiring shall be capable of operating the ADA operator and the card reader on the same door.
- 3. Key override is required on all card access entrances. All lock hardware shall be storeroom function. For each door, contractor will provide (1) BEST COREMAX SFIC, 7 pin, un-combinated core and (2) uncut keys for each lock, verification required for keyway by ISU FM Carpenter Foreman. Installation to be performed by ISU Carpenters.
  - a) Buildings utilizing exterior access control shall have all exterior doors re-cored, including doors not on access control. For each door, contractor will provide (1) BEST COREMAX SFIC, 7 pin, un-combinated core and (2) uncut keys for each lock, verification required for keyway by ISU FM Carpenter Foreman. Installation of cores to be performed by ISU Carpenters.



4. Electronic Hardware – All electrified hardware must be electric strike, electronically released handle, or electrically released exit devices with motorized latch retraction. This hardware shall be designed to be powered by 24-volt DC.

### **C. Monitoring Hardware**

#### 1. Alarm Contacts:

- a) Alarm contact shall be in the normally close state when the door is closed.
- b) Alarm contacts shall be provided at each door panel that is monitored or controlled by the Access Control System. All door panels of a multi-panel/leaf opening shall have individual alarm contacts, to be connected in series.
- c) Alarm contacts shall indicate the position of the door panel/leaf relative to its frame and shall be one of the following:
  - (1) Magnetic contacts mounted recessed in door frame (surface magnets permitted only with ISU FM Systems Manager approval when it is not possible to recess alarm contacts).
  - (2) Magnetic contacts integral to door hardware.
  - (3) Door position switch integral to an electronic strike.
  - (4) Mechanical switch integral to door hardware or plunger switch in frame or door.
- d) Alarm contacts will allow the Access Control System to provide notification of forced entry or door propped conditions.

#### 2. Request to Exit Notification

- a) A “Request to Exit” notification method shall be provided at each door monitored or controlled by the Access Control System. All door panels of a multi-panel/leaf opening shall have individual “Requests to Exit” notification to be wired in parallel, OR be covered by motion sensor(s), to be wired in parallel if more than one.
- b) Request to Exit notification methods shall be passive, and shall be one of the following:
  - (1) Mechanical switch integral to handle that must be turned to exit door.
  - (2) Mechanical switch integral to exit device that must be pushed to exit door.
  - (3) If neither of the above are feasible options, motion sensor(s) mounted in such a way that any person about to exit door(s) will be detected. This may be used only with prior, written approval by ISU FM Systems Manager.
- c) Request to Exit notification method shall be “normally open”, i.e. in the closed state when the method is triggered.



## FACILITIES PLANNING, DESIGN, AND CONSTRUCTION

*Illinois State University*

3. Monitored doors, including egress only doors, shall be permitted to be monitored in groups of no more than 4 (four) doors per bank of doors.
4. Alarm contacts and Request to Exit notification methods shall be wired to Hirsch/Identiv DTLM. See electronic access, reference drawings.

### **D. Equipment Location**

1. All system components shall be accessible for service adjustment, calibration, and repair. Do not install devices where they will be blocked by building infrastructure, including piping, mechanical systems, ductwork, etc.
2. All construction on ISU owned or leased properties (including remodel) for exclusive use by ISU shall be provided with at least 1 (one) electronic access control panel of a capacity sufficient to control and/or monitor the number of doors required as outlined by ISU FM Systems Manager. If the number of doors requested to be controlled exceeds the capacity of 1 (one) access control panel, additional panels shall be provided as required.
  - a) New construction shall include monitoring or control by an electronic access control system, as described in VI (A) for all entrances, either exterior or from adjacent attached structures.
  - b) Existing buildings shall include monitoring or control by an electronic access control system, as described in VI (A) for entrances, either exterior or from adjacent attached structures as required by ISU FM Systems Manager.
3. Panel Room Requirements:
  - a) New construction shall include a security closet with adequate space for all security equipment. Size shall be no less than 3'-0" x 6'-0".
    - (1) The security closets shall be air-conditioned and have an independent entry door requiring electronic access. Equipment shall be located away from the primary room entry and exit paths, in addition to being located away from sources of heat, humidity, and water.
    - (2) Can be shared with data closet.
    - (3) All final equipment locations (wired and/or wireless) require written approval by ISU FM Systems Manager.
  - b) Electronic access installed in an existing building shall include the following criteria below:
    - (1) Existing building equipment locations will be determined based on the scope of the project and the number of doors that are converted to electronic access.
    - (2) The security closets shall have an independent entry door requiring electronic access for all new wired and/or wireless panels.



- (3) Preferred locations are in existing data, electrical, and mechanical rooms.
- (4) All final equipment locations (wired and/or wireless) require written approval by ISU FM Systems Manager.

4. Equipment installed adjacent to or within the same space as the electrical equipment (panels, switchgear, switchboards, transformers, etc.), shall be mounted no closer than 6 feet in any direction of this security access equipment unless written approval is obtained from ISU FM Systems Manager.

#### **E. Emergency Circuits**

1. Control panels and power supplies shall be on a designated emergency power circuit, which shall be backed up by a generator, unless otherwise approved, in writing, by ISU FM Systems Manager.
2. Any other part of the system requiring 120V power shall also be on a designated emergency power circuit, which shall be backed up by a generator, unless otherwise approved, in writing, by ISU FM Systems Manager.

#### **F. Communication**

1. Each Hirsch/Identiv panel shall be provided with Ethernet network connectivity.

### **VII. INSTALLATION**

#### **A. Required Installation**

1. Final software configuration shall be completed by ISU FM. 72-hour notification is required for final configuration.
2. All installations shall be completed in a neat, workmanlike manner.
3. Complete the attached “Panel Wiring Form” and any other documentation as required by ISU FM Systems Manager.

#### **B. HIRSCH/IDENTIV Panel**

1. Access control system panel shall be hardwired to dedicated emergency circuit.
2. Power supply for doors and locks shall be hardwired (no plug-in connection) and shall be located as near the controller as is practical. Final location requires written approved by ISU FM Systems Manager.

#### **C. Wiring**

1. Wire to be provided and/or installed on a project-by-project basis.



## FACILITIES PLANNING, DESIGN, AND CONSTRUCTION

*Illinois State University*

2. All wire and cable shall be UL listed, and shall meet all national, state, and local code requirements for its application.
3. All wire and cable shall meet individual system or subsystem manufacturer specifications.
4. All insulated wire and cable shall conform to the minimum requirements of Insulated Cable Engineers Association (ICEA) Standards.
5. Wire and cable shall comply with the application requirements of the National Electrical Code (NEC), latest edition, regarding cable construction and usage.
6. All input cables and card reader cables shall be grounded at the Hirsch/Identiv panel while taped and insulated at the device.
7. The conductors of wires shall be copper and have conductivity in accordance with the standardization rules of the Institute of Electrical and Electronics Engineers, Inc. (IEEE). The conductor and each strand shall be round and free of kinks and defects.
8. Provide an 8" x 10" x 4" (minimum) J-box above the nearest accessible ceiling on the secured side of door for mounting of MRIA, DTLM, and terminal strips. Prefer location to be directly above the door where accessible. Provide a 1" conduit from this same J-box to nearest cable tray or Hirsch panel location. All terminations in the J-box will be on terminal strips.
9. Wires shall be labeled at the points of termination.

### **D. Wire Types and Sizes**

1. All cable shall be plenum rated.
2. All conductors shall be stranded.
3. All conductor insulation shall be uniquely colored to differentiate conductors within a cable.
4. The following cable shall be used for door access control as a minimum:
  - a) From access control system panel to enclosure required by Section VII.C.8:
    - (1) (1) 22/8 cable, with overall shield or at a minimum one shielded pair (Windy City Wire 444352-08 or equivalent) and (1) 18/4 cable (Windy City Wire 442384 or equivalent).
    - (2) Additional cables may be required for certain applications, confirm with ISU FM Systems Manager for each location.





- (3) From enclosure required by Section VII.C.8 to card reader: (1) cable containing not less than four conductors of size not less than 22 AWG.
  - (4) From enclosure required by Section VII.C.8 to any inputs or ADA pushbuttons: (1) cable containing not less than two conductors of size not less than 22 AWG.
  - (5) From enclosure required by Section VII.C.8 to any electrified door hardware: (1) cable containing not less than two conductors of size not less than 18 AWG.
  - (6) For wireless systems only, from access control system panel to wireless hub or between wireless hubs: (1) cable containing not less than four conductors of size not less than 22 AWG.
  - (7) For all other applications, follow manufacturer recommendations.
5. Spare conductors shall be labeled, secured, and isolated so that they do not contact other conductors at each end.

#### **E. Raceways and Wiring**

1. Installed in accordance with the following:
  - a) *National Electric Code*
  - b) *Illinois State University Design Guidelines*
  - c) *Illinois State University Facilities Standards*
2. A minimum of ¾" conduit is required. (Note: Exception to doorframe EPT-10, doorframe raceway can be ½").
3. All raceways shall use approved connectors at each end and be properly connected to an approved box or fitting.
4. All raceways shall be contained within walls below an accessible ceiling to devices.
5. All wiring connections and terminations shall be accessible.
6. All electronic door access system wiring shall be installed in conduit or cable tray with future available fill capacity.
7. All door hardware raceway and wiring shall be concealed.
8. All door hardware raceway and wiring shall be installed in a neat, workmanlike manner.
9. A minimum distance of 24" shall be maintained between the electronic access system wiring and any conductors carrying voltage of 50 volts line to ground or higher.



10. All conductors carrying voltage of 50 volts line to ground or higher shall be run in separate raceways from communication and other low voltage wiring.

#### **F. Network Connection**

1. Network jacks shall be installed prior to or at the same time as installation of electronic access panel and needs to be coordinated with ISU FM.

#### **G. Testing**

1. ISU FM Systems Manager will appoint team comprised from multiple ISU departments for the purpose of testing, hereafter known as ISU FM Systems Team.
2. Contractor shall coordinate testing with ISU FM Systems Team.
3. Contractor shall submit schedule for acceptance testing a minimum of 15 business days prior to beginning of testing and/or acceptance. ISU FM Systems Manager shall lead test procedures.
4. ISU FM Systems Team shall conduct tests during course of construction when identifiable portion of the installation is complete and at the end of construction.
5. If tests fail to meet specifications, adjust, change, and/or relocate as necessary, then repeat tests. Any corrections to meet specifications shall be at no additional cost.
6. All systems shall be commissioned by the ISU FM Systems Manager upon completion of project. A minimum of 3 business days in advance notice is required.
7. Contractor will be required to coordinate with and to permit ISU FM Systems Team to test and verify all cables and wiring system hardware prior to final building inspections.

### **VIII. SPECIALTY REQUIREMENTS**

#### **A. Residence Halls**

1. All residence halls or other spaces used to provide housing to ISU students or faculty/staff shall have the following requirements:
  - a) All exterior doors to these structures shall be monitored or controlled by an electronic access control system, as described in VI (A).



## FACILITIES PLANNING, DESIGN, AND CONSTRUCTION

*Illinois State University*

- b) All doors leading to or from an adjacent attached structure (ex. dining center) not controlled by ISU University Housing Services shall be monitored or controlled by an electronic access control system, as described in VI (A).
- c) All entrances, either exterior or from adjacent attached structures which are not controlled by ISU University Housing Services, designed for student access to the space shall be locked and unlocked by the electronic access control system, with at least 1 (one) door in any bank of doors being provided with key override as required in *ISU Facilities Standards* Section 08 71 00 – Door Hardware.
- d) Monitored doors, including egress only doors, shall be permitted to be monitored in groups of no more than 4 (four) doors per bank of doors as described in VI (C).
- e) At least 1 (one) door in a bank of doors shall be operated through a card reader as described in VI (A-5), mounted on the exterior of the building or integral to the door hardware.
- f) Where an ADA compliant operator is required at an entrance, the door hardware and wiring shall be capable of operating the ADA operator and the card reader on the same door.
- g) At least 1 (one) power supply as described below shall be provided with each Hirsch controller as described in VI (A-3). Additional power supplies shall be furnished as required by ISU FM Systems Manager.

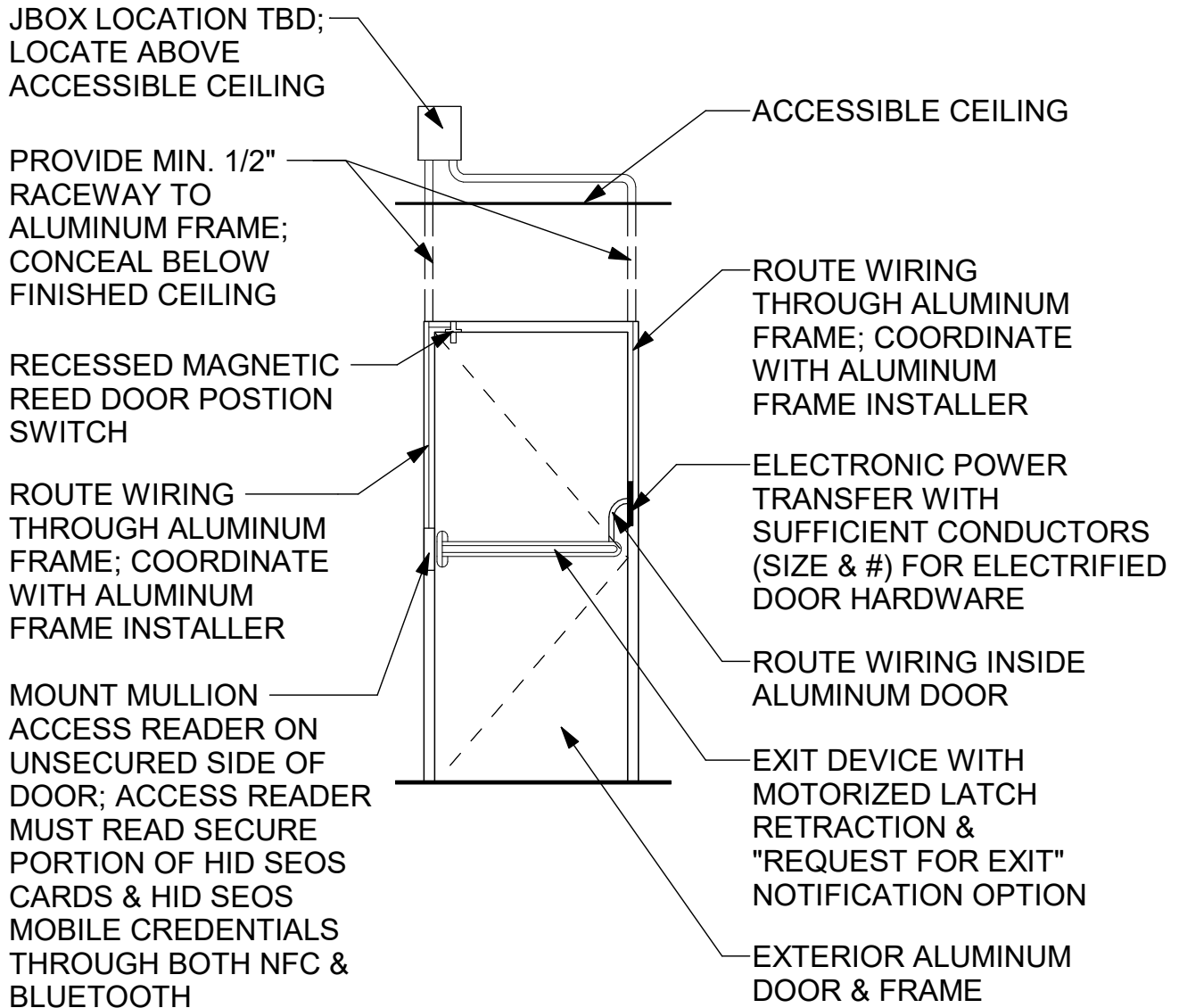

1 ALUMINUM DOOR & FRAME  
A1.1 3/8" = 1'-0"

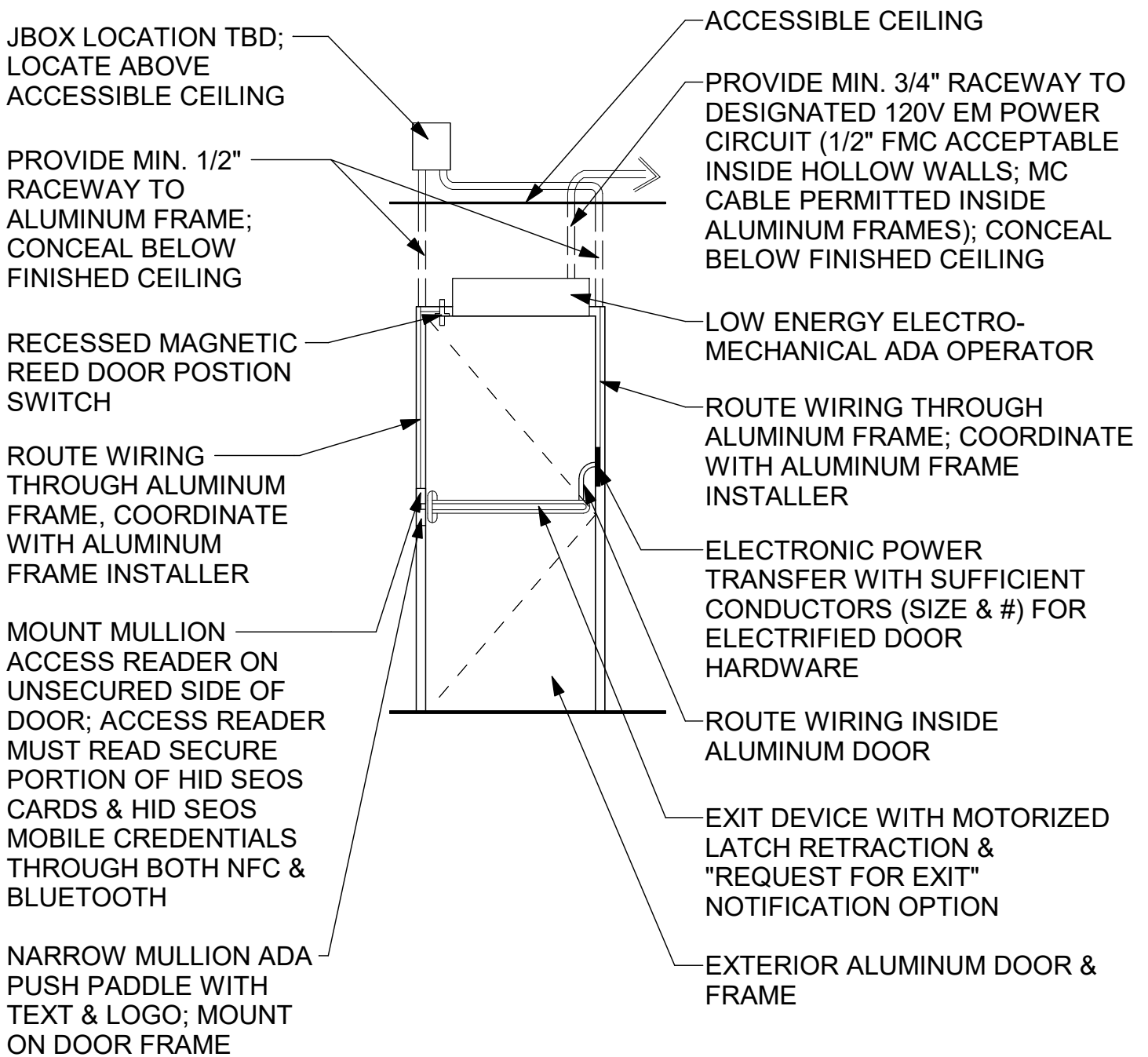

1 ALUMINUM DOOR & FRAME WITH ADA HARDWARE  
 A1.2 3/8" = 1'-0"

 <b>FACILITIES PLANNING AND CONSTRUCTION</b> Illinois State University <small>100 South Fell, Suite 102 • Normal, IL 61790-3390 • (309) 438-8606</small>	<b>EXTERIOR SINGLE DOOR - ALUMINUM DOOR &amp; FRAME WITH ADA HARDWARE</b>  ISU FACILITIES STANDARDS Normal, IL 61761	PROJECT NO.	DATE
		Exhibit FS-8.1	
		SHEET	
		<b>A1.2</b>	

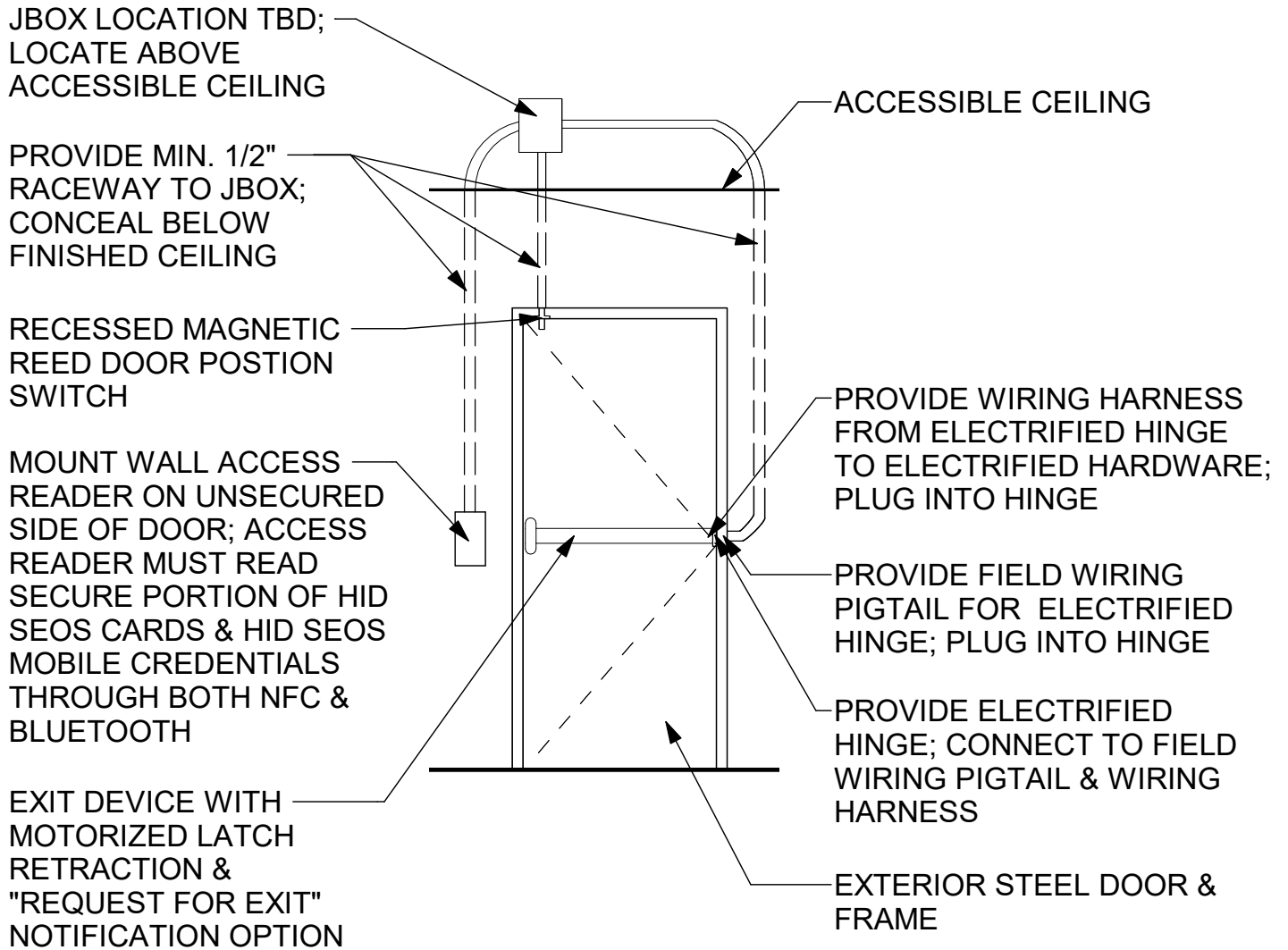

1 **STEEL DOOR & FRAME**  
A1.3 3/8" = 1'-0"

 <b>FACILITIES PLANNING AND CONSTRUCTION</b> <i>Illinois State University</i> <small>100 South Fell, Suite 102 • Normal, IL 61790-3390 • (309) 438-8606</small>	<b>EXTERIOR SINGLE DOOR - STEEL DOOR &amp; FRAME</b>  ISU FACILITIES STANDARDS Normal, IL 61761	PROJECT NO.	DATE
		Exhibit FS-8.1	
		SHEET	
		<b>A1.3</b>	

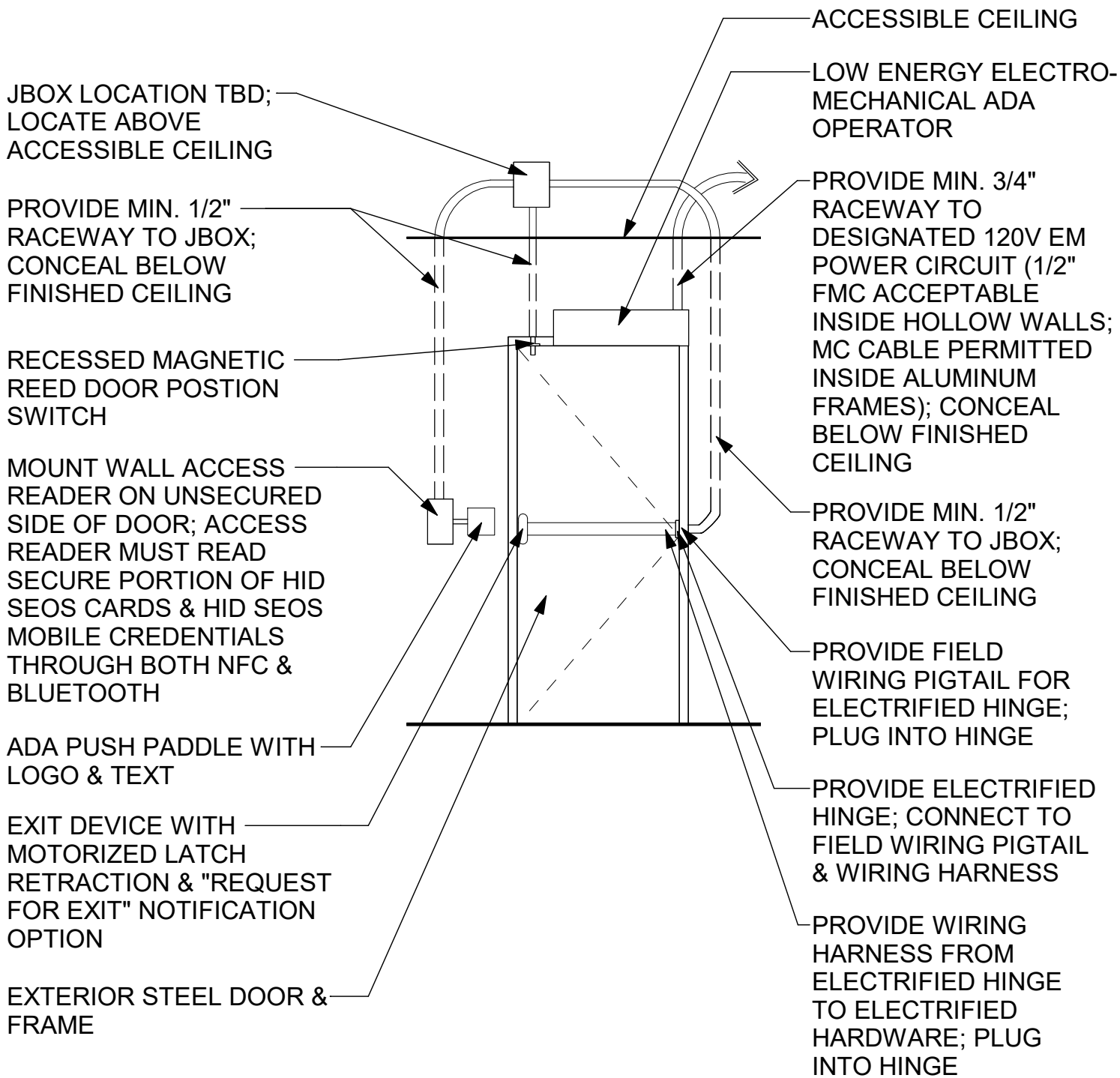

**1 STEEL DOOR & FRAME WITH ADA HARDWARE**

A1.4 3/8" = 1'-0"

 <p><b>FACILITIES PLANNING AND CONSTRUCTION</b>          Illinois State University          100 South Fell, Suite 102 • Normal, IL 61790-3390 • (309) 438-8606</p>	<p><b>EXTERIOR SINGLE DOOR - STEEL DOOR &amp; FRAME WITH ADA HARDWARE</b></p> <p>ISU FACILITIES STANDARDS          Normal, IL 61761</p>	PROJECT NO.	DATE
		Exhibit FS-8.1	
		SHEET	
		<b>A1.4</b>	

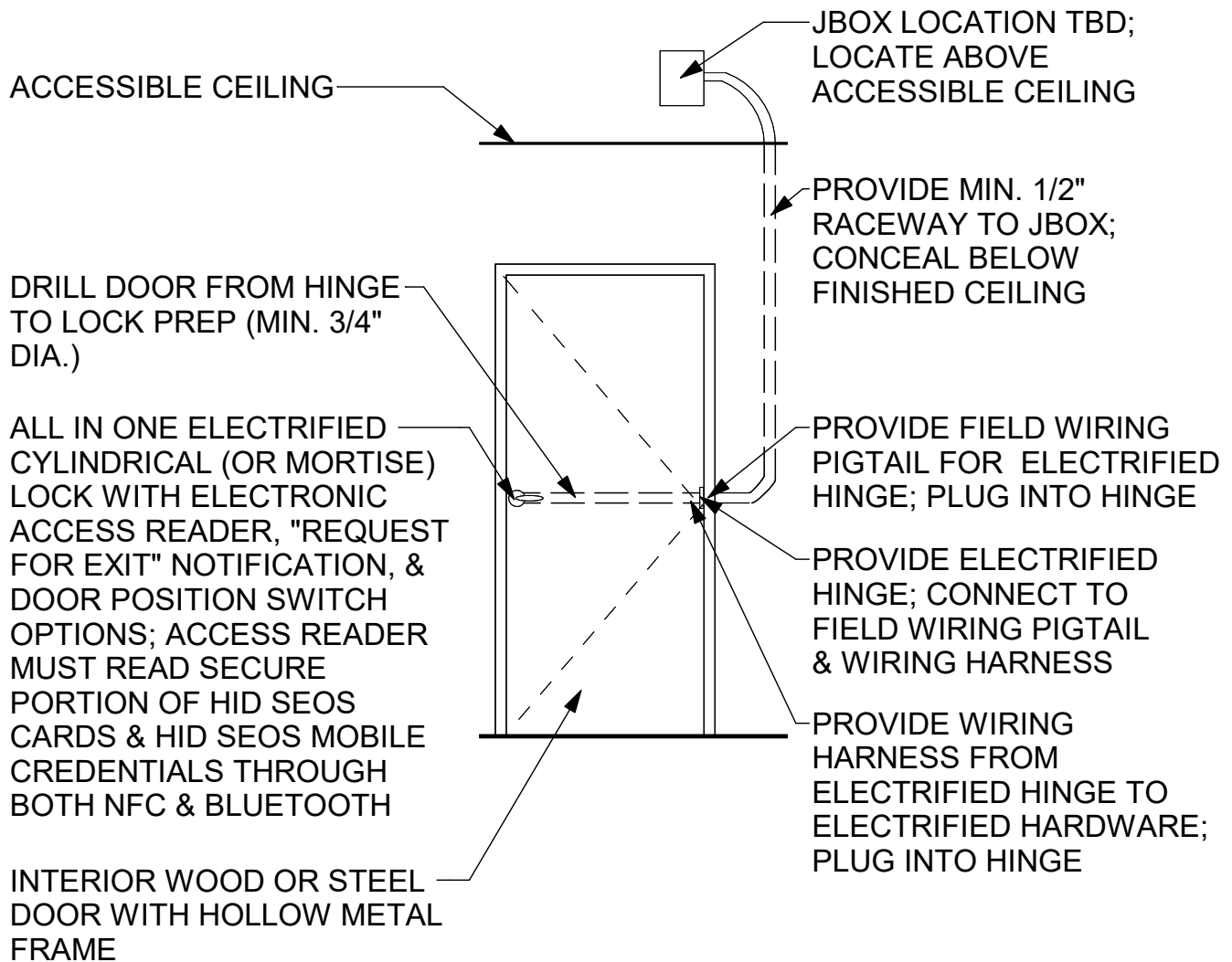

1 WOOD/STEEL DOOR WITH HOLLOW METAL FRAME  
 A2.1 3/8" = 1'-0"



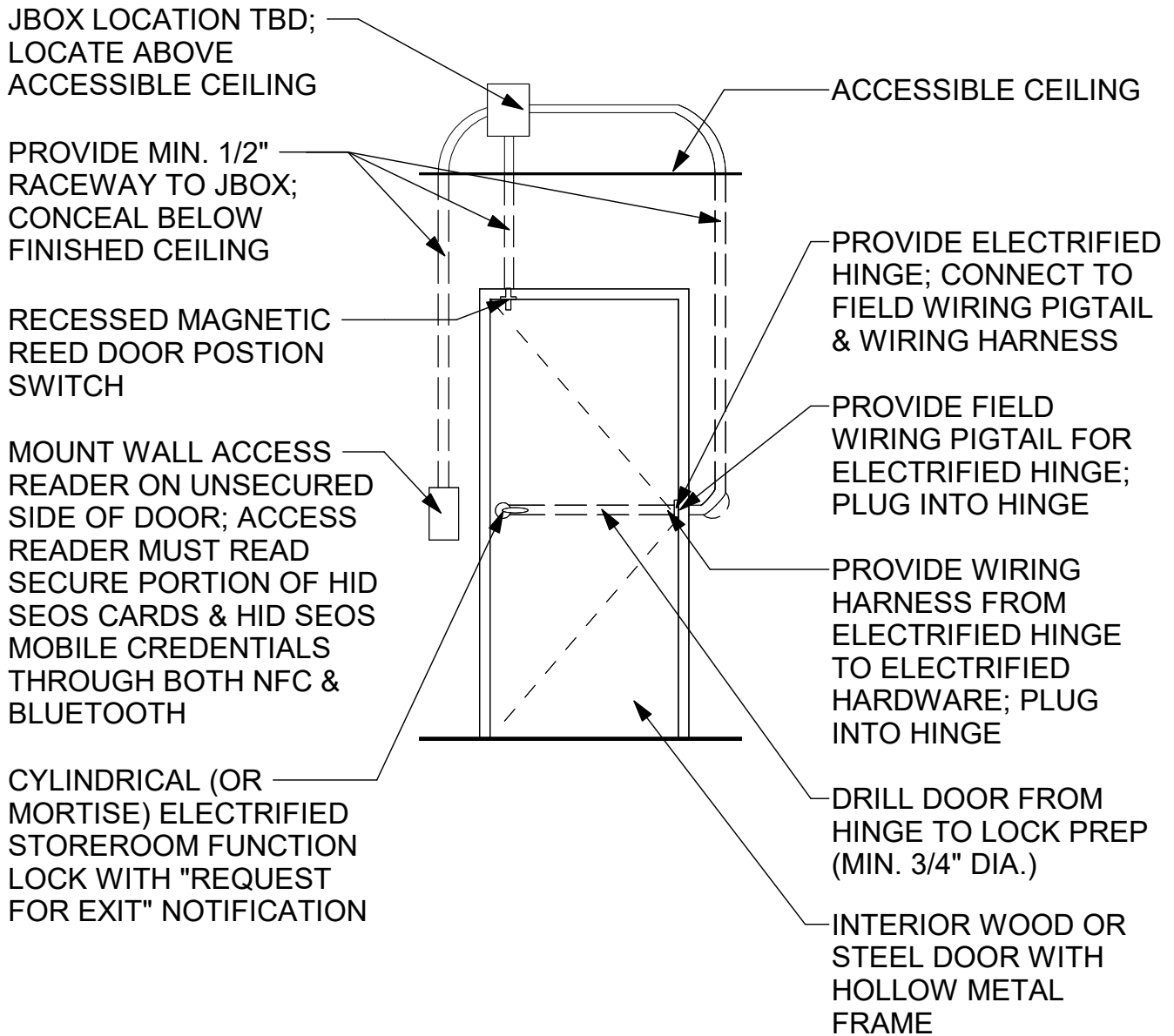

1 **WOOD/STEEL DOOR WITH H.M. FRAME & READER**  
 A2.2 3/8" = 1'-0"

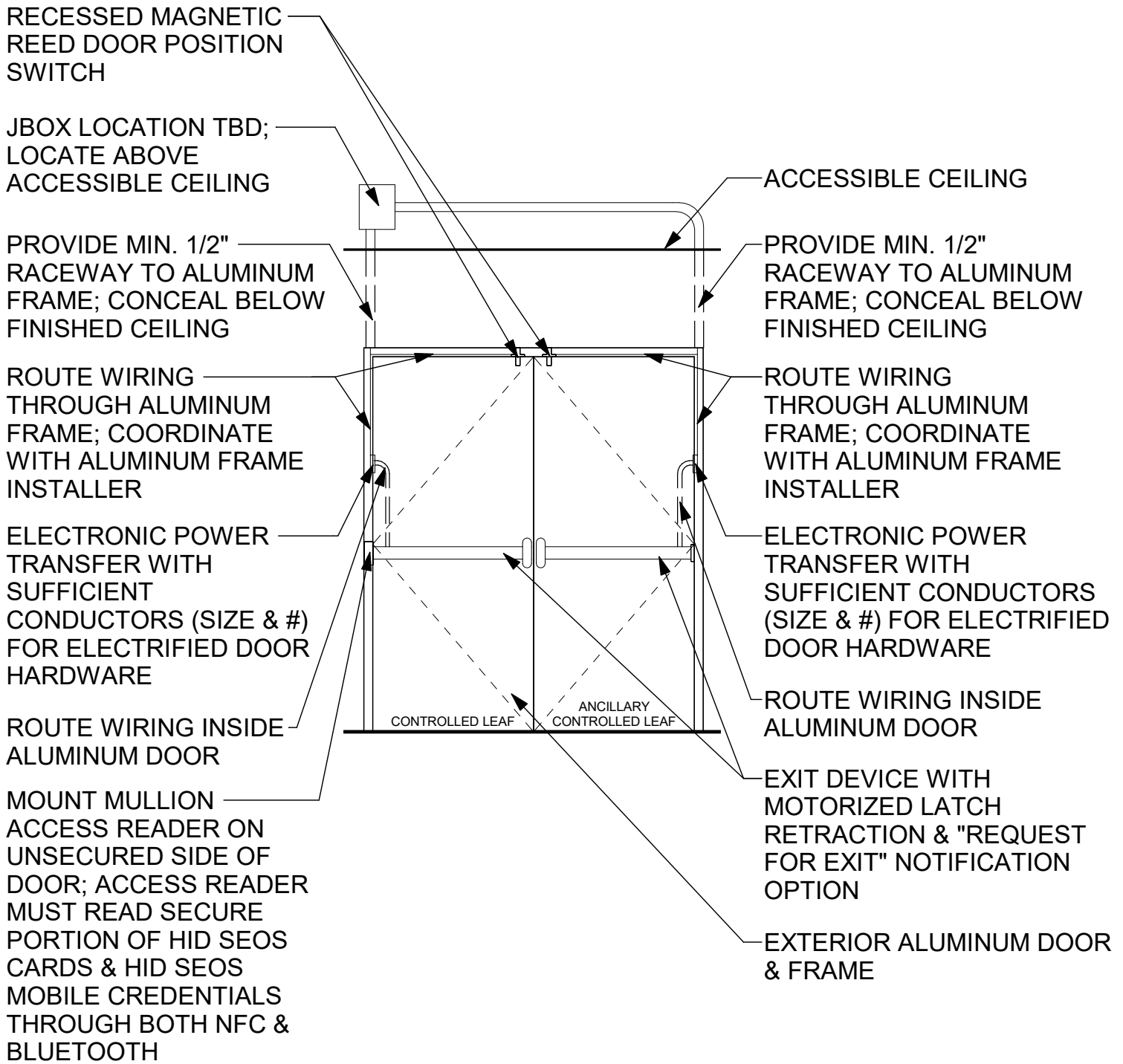

1 ALUMINUM DOOR & FRAME  
 A3.1 3/8" = 1'-0"

 <b>FACILITIES PLANNING AND CONSTRUCTION</b> Illinois State University <small>100 South Fell, Suite 102 • Normal, IL 61790-3390 • (309) 438-8606</small>	<b>EXTERIOR DOUBLE DOOR - ALUMINUM DOOR &amp; FRAME</b>  ISU FACILITIES STANDARDS Normal, IL 61761	PROJECT NO.	DATE
		Exhibit FS-8.1	
		SHEET	
		<b>A3.1</b>	

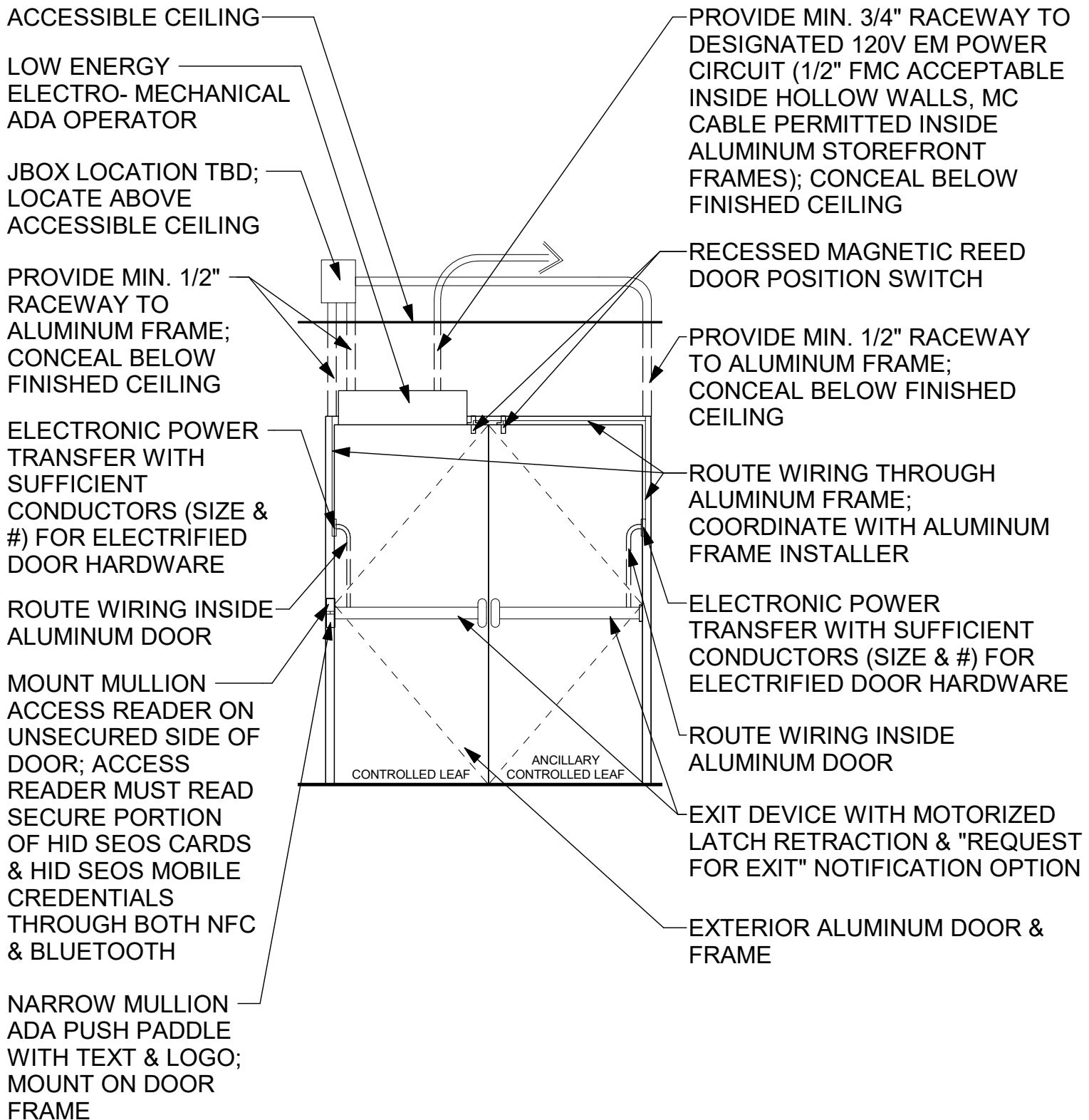

**1** ALUMINUM DOOR & FRAME WITH ADA HARDWARE  
 A3.2 3/8" = 1'-0"

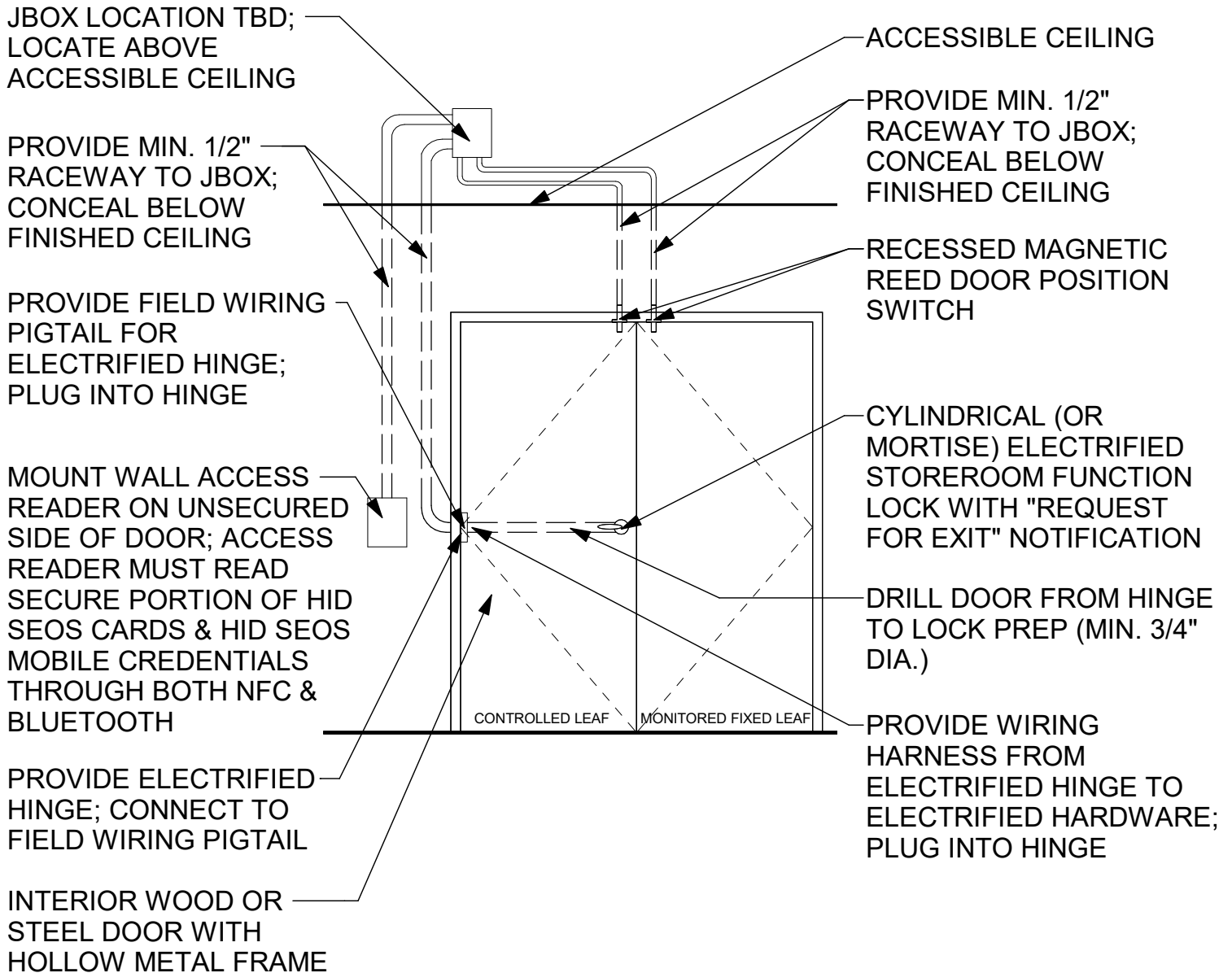

1 WOOD/STEEL DOOR WITH H.M. FRAME & READER  
 A4.1 3/8" = 1'-0"

 <b>FACILITIES PLANNING AND CONSTRUCTION</b> Illinois State University <small>100 South Fell, Suite 102 • Normal, IL 61790-3390 • (309) 438-8606</small>	<b>INTERIOR DOUBLE DOOR - WOOD/STEEL DOOR WITH H.M. FRAME &amp; READER</b>  ISU FACILITIES STANDARDS Normal, IL 61761	PROJECT NO.	DATE
		Exhibit FS-8.1	
		SHEET	
		<b>A4.1</b>	

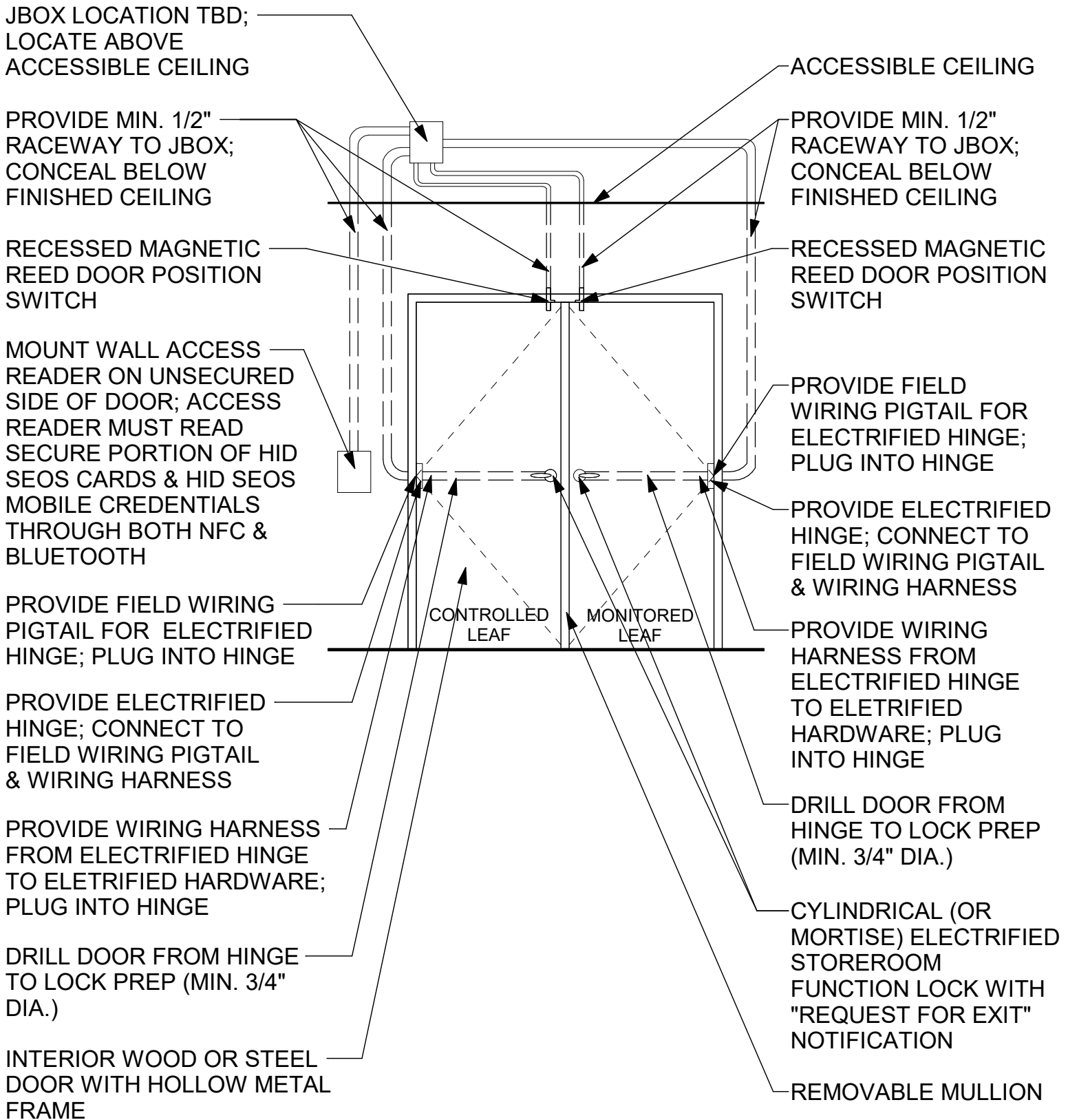

1  
A4.2

# WOOD/STEEL DOOR WITH H.M. FRAME & MULLION

3/8" = 1'-0"



## INTERIOR DOUBLE DOOR - WOOD/STEEL DOOR WITH H.M. FRAME & MULLION

ISU FACILITIES STANDARDS  
Normal, IL 61761

PROJECT NO. Exhibit FS-8.1	DATE
SHEET	

# A4.2

## ELECTRONIC ACCESS: PANEL WIRING FORM

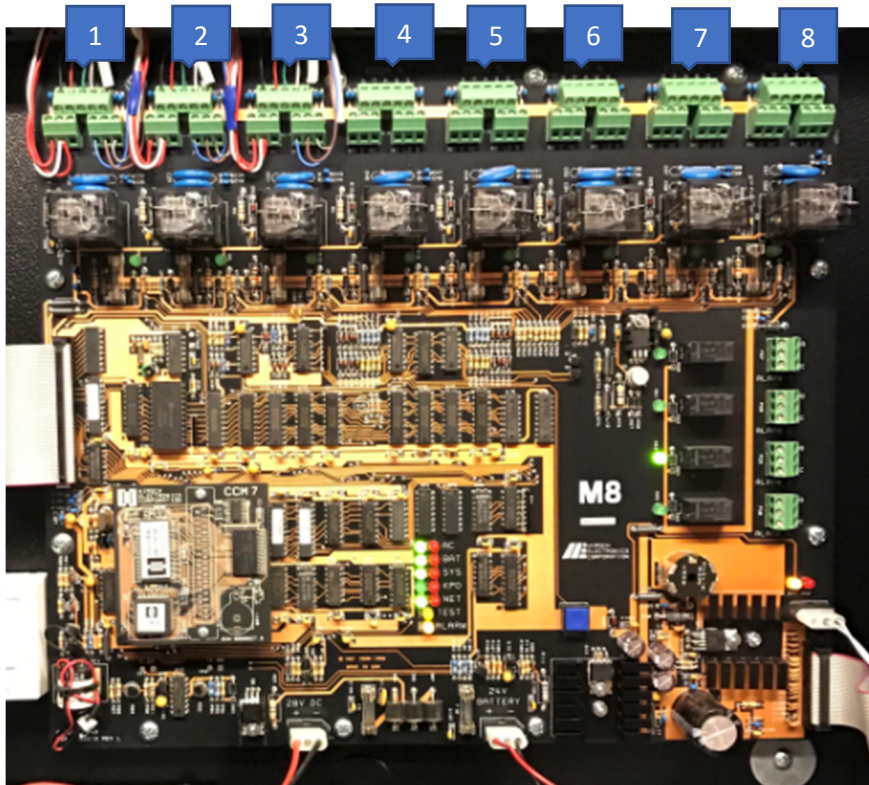

1. Wired to Door: \_\_\_\_\_

2. Wired to Door: \_\_\_\_\_

3. Wired to Door: \_\_\_\_\_

4. Wired to Door: \_\_\_\_\_

5. Wired to Door: \_\_\_\_\_

6. Wired to Door: \_\_\_\_\_

7. Wired to Door: \_\_\_\_\_

8. Wired to Door: \_\_\_\_\_

Contractor: \_\_\_\_\_

Form Prepared By (Please Print): \_\_\_\_\_

Signature: \_\_\_\_\_ Date: \_\_\_\_\_